

Kopis freestyle 4inch Assembly Guide (HD Version)

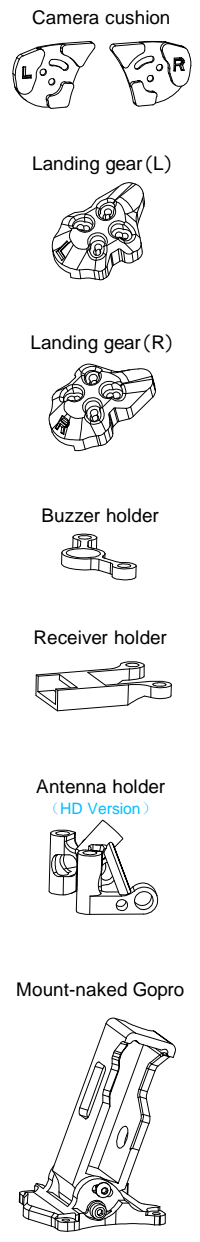

※ Two ways for you to mount your camera onto the side panel:

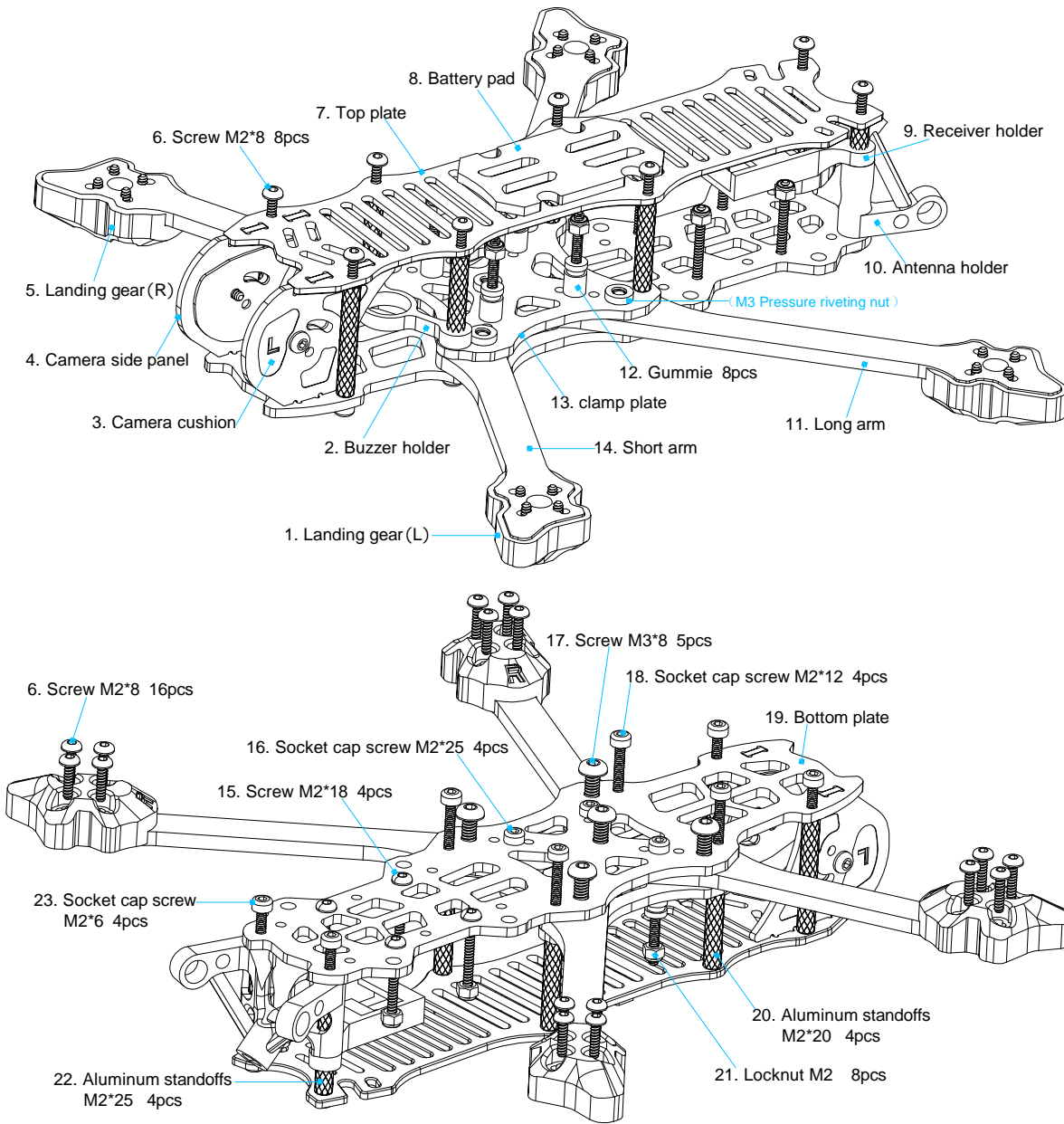
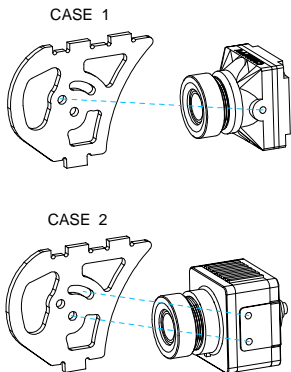

※ Arm adapting to 2 kinds of motors:

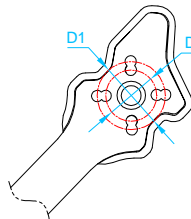

- ① D1=12mm, for a motor with 12mm mounting hole;
- ② D2=9mm, for a motor with 9mm mounting hole.

※ Antenna holder adapting to 3 kinds of antenna:

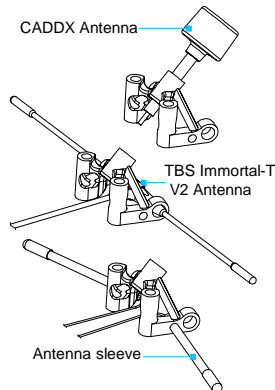

※ Figures for your reference, for installing a DJI FPV kit. Please download the corresponding STL file from HolyBro website for printing the part you need by yourself:

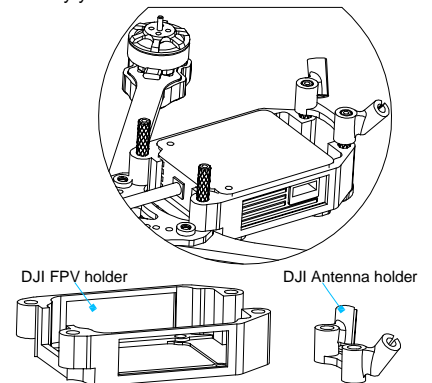

Kopis freestyle 4inch Assembly Guide (Analog Version)

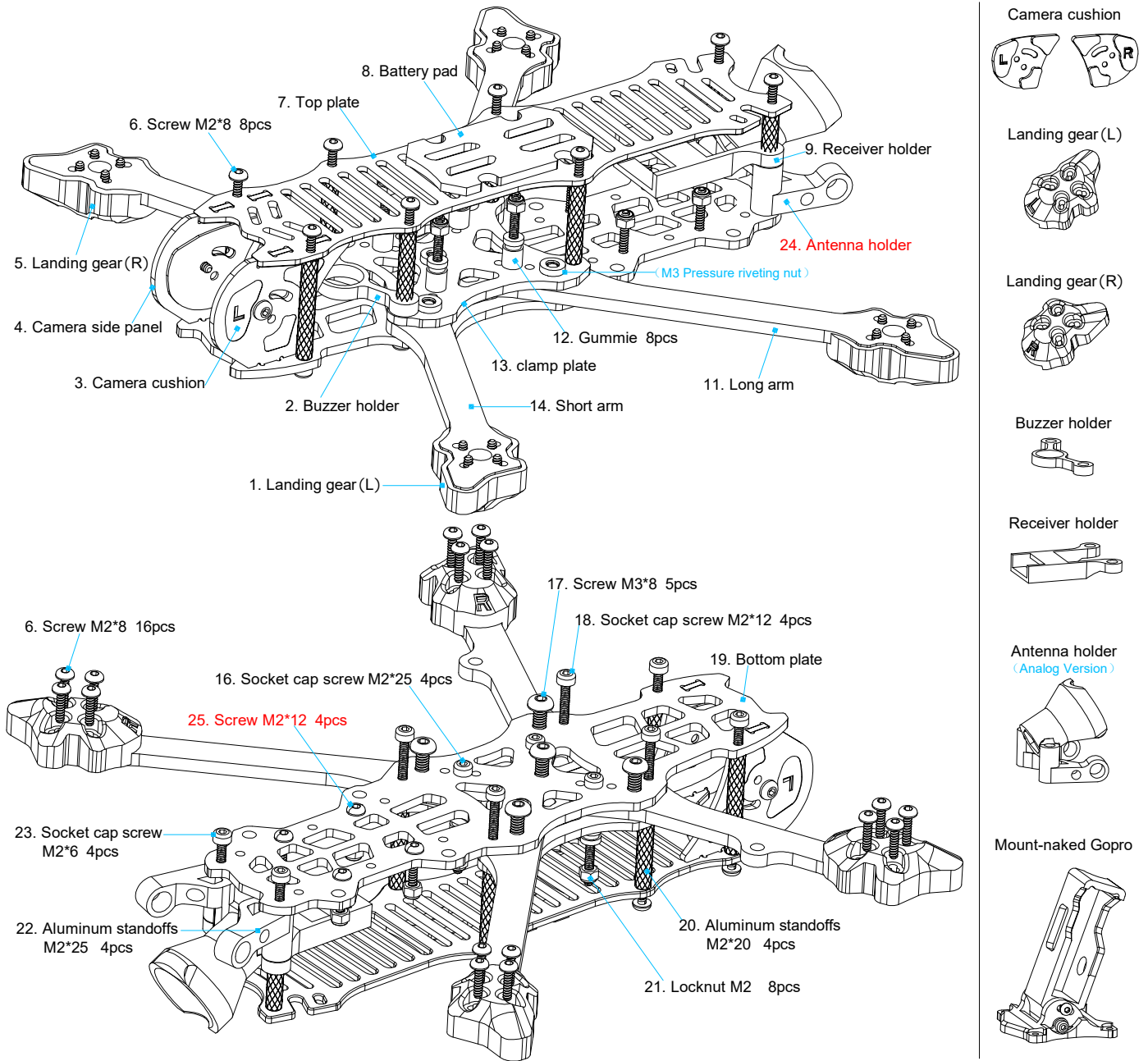

※ Two ways for you to mount your camera onto the side panel:

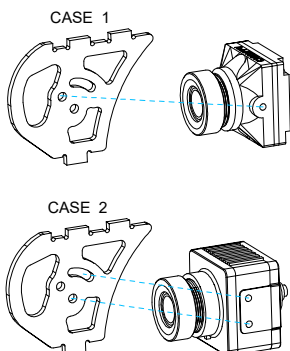

※ Arm adapting to 2 kinds of motors:

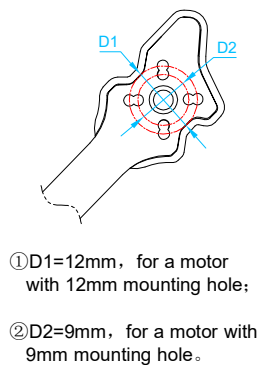

※ Antenna holder adapting to 3 kinds of antenna :

